



AC hipot test

Insulation Resistance

AC AUTOMATIC INSULATION/  
WITHSTANDING HiTESTER

**3174**

General model



AC/DC hipot test

Insulation Resistance

AUTOMATIC INSULATION/  
WITHSTANDING HiTESTER

**3153**

Supports multiple test points

## Fast, reliable insulation testing of electrical products and components

Available as a standard model and as a multipoint-capable model  
for use in automatic test systems



# High-voltage scanner and program mode for automating continuous testing with different test conditions

Combine with the High Voltage Scanner 3930 to test large numbers of points at once.



## AUTOMATIC INSULATION / WITHSTANDING HiTESTER 3153



Transformer capacity

500 VA

### Voltage Withstand Testing

AC: 0.20 to 5.00 kV, 500 VA, 0.01 to 100.0 mA AC  
DC: 0.20 to 5.00 kV, 50 VA, 0.01 to 10.0 mA DC

### Insulation Testing

DC: 50 to 1200 V  
0.10 to 9999 MΩ

#### Model No. (Order Code)

3153 Insulation, AC/DC Withstanding Voltage

Included accessories: H.V. Test Lead 9615 (high voltage side and return, 1 each) x1, Power cord x1, Instruction manual x1, Spare fuse x1

#### H.V. TEST LEAD 9615

Red, Black each 1,  
1.5 m (4.92 ft) length



## HIGH VOLTAGE SCANNER 3930



By switching its internal high-voltage relays on and off, the 3930 can output high-voltage input from the Insulation/Withstanding HiTester's high-voltage input cord to a user-specified channel.

#### Model No. (Order Code)

3930 For the 3153 and similar products

Included accessories: Control input connector connection cable x1, H.V. Test Lead 9615-01 (red) x8, H.V. Test lead 9615-02 (black) x1, Grounding cable x1, Instruction manual x1

#### H.V. TEST LEAD 9615-01

Red, high voltage side,  
1.5 m (4.92 ft) length



### Multiple channels



Set each 3930's ID with the ID setting dial to connect and control up to four units, allowing the device to be expanded to a large number of channels.

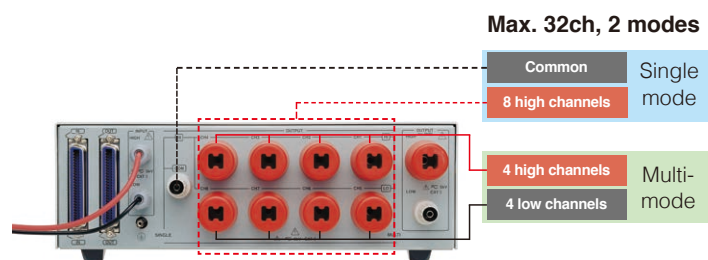

Choose single mode to test eight groups consisting of the COM terminal and the unit's eight high-voltage output terminal channels (by connecting the CH1 through 8 terminals to high-voltage output) or multi-mode to test four groups consisting of pairs of different high-voltage output terminals (by connecting CH 1 through 4 to high-voltage output and CH 5 through 8 to COM).

# Program Mode

If you store test conditions in the instrument's memory in advance, you can avoid the need to configure conditions for each test. You can easily choose and load setting condition files either manually or automatically, even in multi-model, small-lot production settings.

## Using a PLC to automate file loading

You can use the external I/O terminal on the rear of the instrument to control the selection and loading of files from a PLC. You can also choose and load the file to test manually using the **PG.LOAD** key.



External I/O terminal

**You can configure up to 32 files of test sequences and test conditions, each with up to 50 steps.**

Up to 32 files

Up to 50 steps

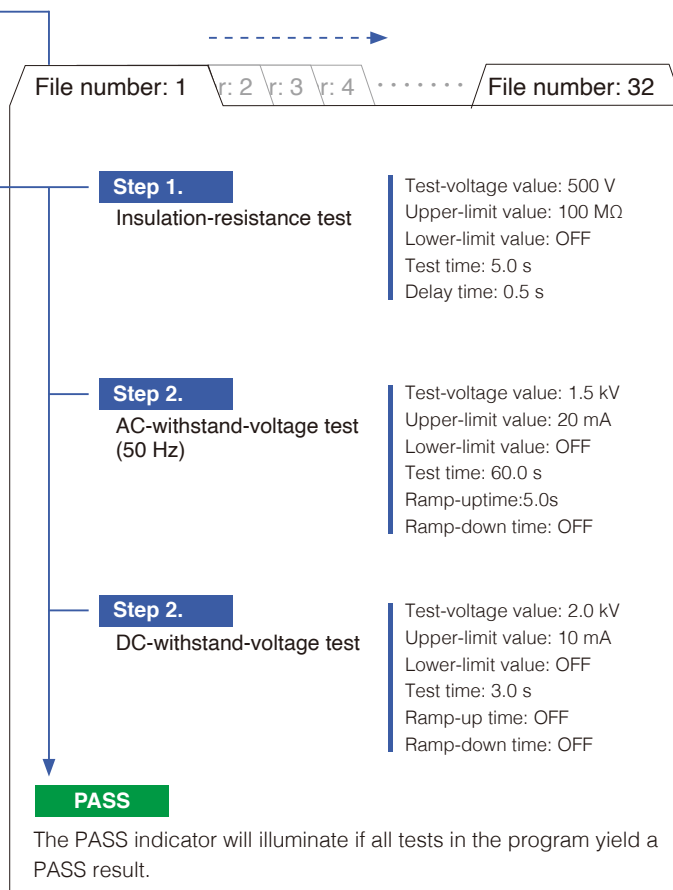

The external I/O terminal helps automate testing to an even greater degree by providing terminals for 3153 test status, judgment signal output (PASS/FAIL), and START/STOP and other control signals.

Connect up to four units.

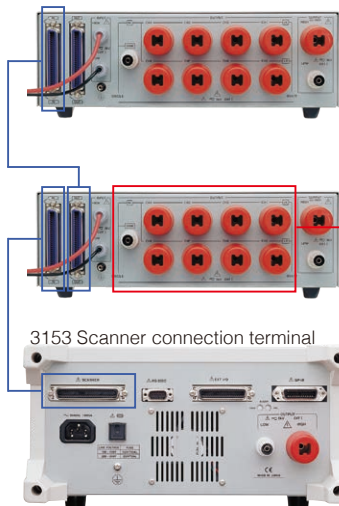

## When used with the 3930 in multipoint testing

When editing test conditions while using the 3930, you can set which scanner channel numbers to use in each step.

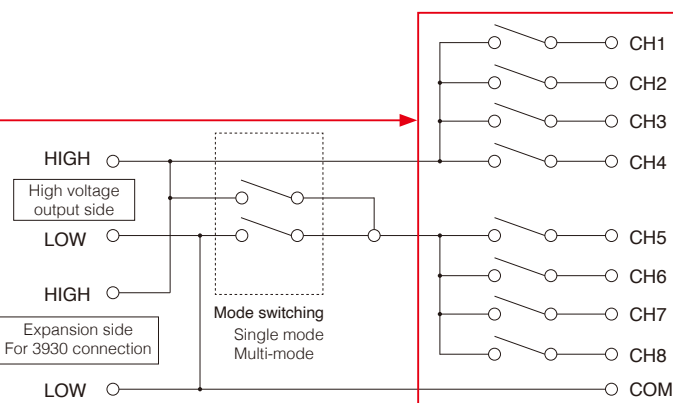

# Resolve test issues caused by test lead wire breaks and incomplete contact.



## AC AUTOMATIC INSULATION/WITHSTANDING HiTESTER 3174

Transformer capacity  
**100 VA**

### Voltage Withstand Testing

AC: 0.20 to 5.00 kV, 100 VA, 0.01 to 20.0 mA AC

### Insulation Testing

DC: 50/1000 V  
0.5 to 2000 MΩ

### Model No. (Order Code)

3174 Insulation, AC Withstanding Voltage

Included accessories: H.V. Test Lead 9615 (high voltage side and return, 1 each) x1, Power cord x1, Instruction manual x1, Disconnection prevention plate x1

H.V. TEST LEAD 9615  
Red, Black each 1,  
1.5 m (4.92 ft) length



To perform contact checks, please purchase another H.V. Test Lead 9615 set.

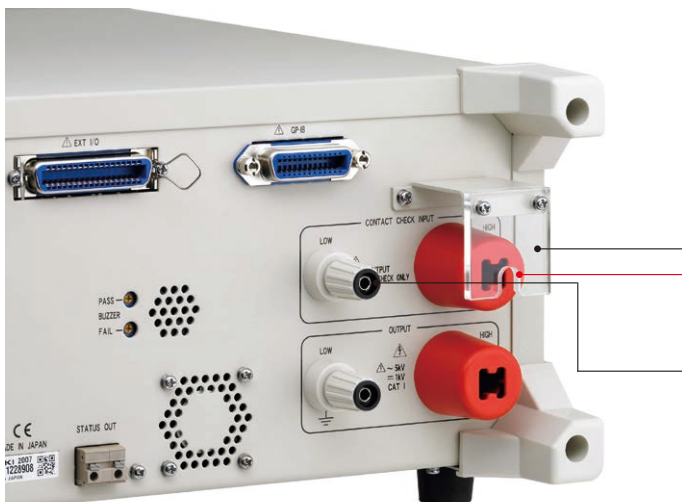

## Improve test reliability with the contact check function.

The contact check function can detect test lead wire breaks and incomplete contact during testing, allowing measurement issues to be detected in real time.

A plate keeps test leads from being disconnected.

HIGH: Determines that a wire break has occurred if the measurement voltage for contact checks exceeds upper and lower threshold values.

LOW: Determines that a wire break has occurred if the check current is not detected.

## Issue

Defective parts are determined to be non-defective due to erroneous judgments.

A test lead was disconnected from the connector.  
There was a wiring break in a test lead

## Solution example Contact Check Function

Verify that the test leads are properly connected by measuring the voltage across the device under the test's terminals.

Can detect anomalous output voltages from the Withstanding HiTester.  
In the event of an anomalous output voltage, it reports an error number and stops the test.

\*Use of the contact check function does not increase cycle times.

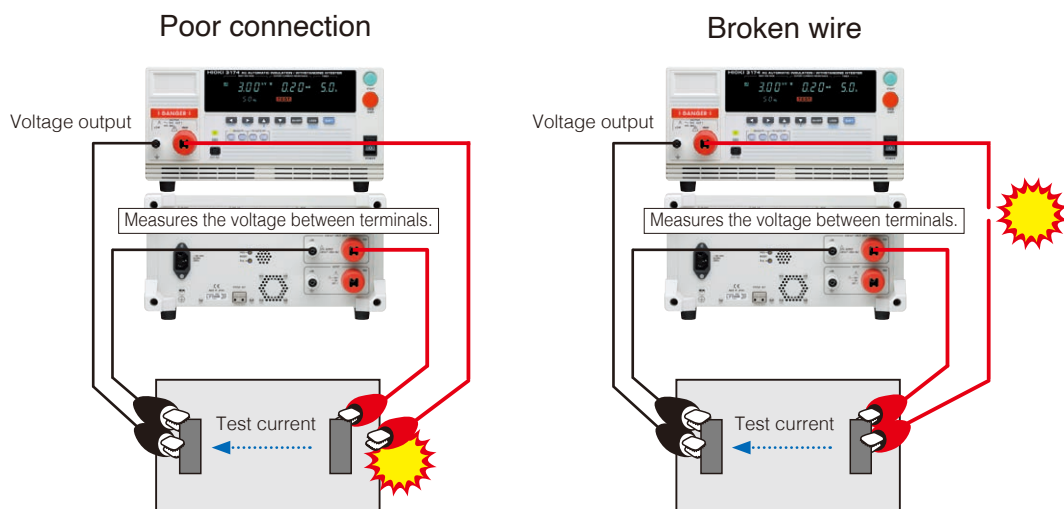

\*To perform contact checks, you will need to purchase another H.V. Test Lead 9615 set (one comes standard with the instrument) (optional).

H.V. Test Lead 9615



High voltage side and return, 1 each (1.5 m)

## Continuous Test Mode

Although testing will stop immediately in the event of a FAIL test result, it's not possible to determine whether that result was caused by a short-circuit or a threshold value being exceeded. You can analyze FAIL results by using continuous test mode.

Only Withstanding-Test

## Evaluate even for forced termination of test

Although judgment results ordinarily are not displayed when testing is forcibly terminated, you can have the instrument display them by enabling this function, allowing a judgment to be determined even when testing is stopped. This capability increases the degree of freedom with which testing can be performed.

## Improve test reliability and safety.



**AUTOMATIC INSULATION/WITHSTANDING HIESTER**  
**3153**



**AC AUTOMATIC INSULATION/WITHSTANDING HIESTER**  
**3174**

### Generate output without being affected by fluctuations in the supply voltage.

Use of a PWM switching power supply ensures the user-configured test voltage will be output. As a result, test voltages are not affected by fluctuations in the supply voltage, further improving the reliability of test results.

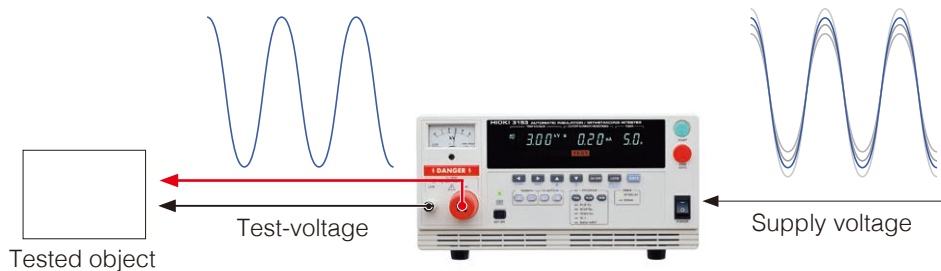

### Control the test voltage during withstanding testing.

Suddenly applying a high test voltage to some devices produces transient phenomena. By setting ramp-up and ramp-down times to control the test voltage rising and falling times, you can increase the voltage gradually so that the set test voltage is not applied abruptly.

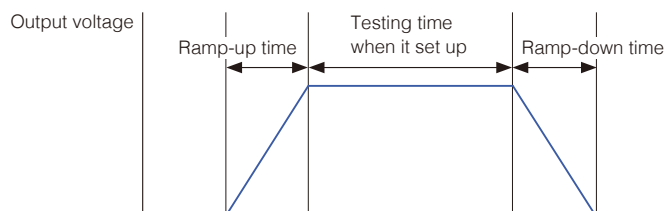

#### Ramp-up operation

The output voltage is gradually increased from the initial voltage to the test voltage over the course of the ramp-up time.

#### Ramp down operation

After the test timer has elapsed, the test voltage is decreased from the set voltage to 0 V over the course of the ramp-down time, and the remaining time is counted down on the display.

### Discharge any residual charge.

If the device under test has a capacitive component, withstanding testing can leave a charge, posing a risk of electric shock. The 3153 and 3174 provide an automatic discharge function that automatically switches to an internal discharge circuit to dissipate any charge remaining after withstanding testing is complete.

### Prevent unintended operation.

The external I/O interlock function lets you cut off 3153 and 3174 output in conjunction with an external device. This function disables all key operation to ensure safety, for example during automatic testing.

## Specifications

Withstand Voltage test portion	3153	3174
AC output voltage	AC 0.20 kV to 5.00 kV	AC 0.20 kV to 5.00 kV
DC output voltage	DC 0.20 kV to 5.00 kV	–
Voltage output method	AC: PWM switching (Zero-toggle switch) DC: PWM switching	AC: PWM switching (0 V start, Voltage change during supply possible)
Transformer capacity	AC: 500 VA (30 min max.)	100 VA AC, continuous
Output capacity	DC: 50 VA (continuous)	–
Voltage setting method	Digital setting, Setting resolution: 0.01 kV	
Output voltage accuracy	±(1.5% of the setting value+2 dgt.)	±1.5% of the setting value ±20 V
Output frequency	50Hz/60Hz	50Hz/60Hz
Current	AC: 100 mA DC: 10 mA (continuous)	AC: 20 mA
Voltage measurement	AC: Average value rectified effective value display DC: Average value display	AC: True RMS indication
	Digital: 0.00 - 5.00 kV AC (full-scale) Accuracy 1.5%f.s.	Digital: 0 to 1.00 kV rms AC Withstand-voltage, Accuracy ±15 V 1 to 5.00 kV rms AC Withstand-voltage, Accuracy ±1.5% rdg
Current measurement range	AC: 0.01 mA to 100.0 mA DC: 0.01 mA to 10.0 mA	AC: 0.01 mA to 20.0 mA
Current measurement accuracy	±(2% rdg.+5dgt.) for all ranges *2	±(2% rdg.+ 5dgt.) for all ranges
Ramp timer (Withstand-voltage test)	Setting range: 0.1 to 99.9 s Ramp-up and ramp-down times can be set separately.	Setting range: 0.1 to 99.9 s Ramp-up and ramp-down times can be set separately.
Insulation resistance test portion		
Test Voltage	50 to 1200 V DC (positive electrode) Voltage testing method: Digital setting (Setting resolution: 1 V) Accuracy: ±(1.5% of the setting value+2 dgt.)	500 V/1000 V DC (positive electrode) No load voltage: 1 to 1.2 times of rated voltage
Voltage measurement	Digital: 0 to 1200 V DC (full-scale) Accuracy ±(1.5%rdg.+2 dgt.) Analog: 0 to 1200 V DC Accuracy 5%f.s. (full-scale: 5 kV)	Digital: 0 to 1000 V DC Accuracy ±30 V Analog: None
Measurement range/Accuracy	0.100 MΩ to 1.049Ω 1.05 MΩ to 10.49 MΩ *1 10.5 MΩ to 104.9 MΩ *1 105 MΩ to 9999 MΩ *1 (representative values for 0.5 MΩ to 1,000 MΩ): ±4% rdg. *2	0.5 MΩ to 999 MΩ(500V): ±4% rdg. 1 MΩ to 999 MΩ(1000V): ±4% rdg. 1000 MΩ to 2000 MΩ: ±8% rdg.
Delay timer Time during which screening is not performed from the start of a test (delay time) can be set.	Setting range: 0.1 to 99.9 s	Setting range: 0.1 to 99.9 s
Common specification		
Decision contents	UPPER-FAIL: When measured resistance exceeds the upper-limit setting. PASS: When measured resistance is within the upper-limit and lower- limit settings. LOWER-FAIL: When the measured resistance is below the lower-limit setting.	
Decision process	Output to the display, beeper sound, signals to EXT I/O for each decision result	
Test Time Timer: Operation	0.3 s to 999 s	0.3 s to 999 s
	At ON Setting : Displays the time that is counted down from the start At OFF Setting: Displays the time that has elapsed from the start	
RS-232C	✓	✓
GP-IB	✓	–
EXT I/O	Open collector output, (insulated with a photocoupler), All signals Active LOW, Maximum load voltage: 30 V DC	
External Switch Terminal	START, STOP, SW.EN (External Switch Terminal valid)/Input signal (contact input)	
Supply voltage	100 to 120 V AC (Fuse: 250VT10AL) 200 to 240 V AC (Fuse: 250VT5AL) Please specify supply voltage at time of order (as the fuse used depends on the supply voltage).	100 to 240 V AC
Maximum rated power	1000 VA	200 VA
Dimensions	Approx. 320W×155H×480D mm (12.6W×6.1H×18.9D in.) (excluding protruding parts)	Approx. 320W x 155H x 395D mm (12.6W x 6.1H x 15.6D in.) (excluding protruding parts)
Mass	Approx. 18 kg (634.9 oz.)	Approx. 15 kg (529.1 oz.)
Included accessories	H.V. Test lead 9615 (high voltage side and return, 1 each) ×1, Power cord ×1, Instruction manual ×1, Spare fuse* ×1 *: To be designated at the time of ordering, in accordance with the power-supply voltage to be used	H.V. Test lead 9615 (high voltage side and return, 1 each) ×1, Power cord ×1, Instruction manual ×1, Disconnection prevention plate ×1
Applicable Standards	EMC: EN61326 Safety: EN61010	EMC: EN61326 Safety: EN61010
Operating temperature and humidity	0°C to 40°C (32°F to 104°F), 80% RH or less (no condensation)	
Storage temperature and humidity	-10°C to 50°C (14°F to 122°F), 90% RH or less (no condensation)	
Temperature and humidity range for guaranteed accuracy	23±5°C (73 ±9°F), 80% RH or less (no condensation)(after 10 minutes minimum warm-up)	
Operating environment	Indoors, Pollution degree 2, Up to 2000 m (6562-ft.)	

\*1 Measurement range varies with test voltage. \*2 Additional accuracy term applies when using scanner.

# HIGH VOLTAGE SCANNER 3930

(For the 3153 and similar products)



## Specifications

Rated voltage used	AC	5 kV (rms)
	DC	5 kV (rms)
Operation modes	Multi- and single modes	
Mode setting method	External switch	
Number of channels	Multi-mode: 4 high channels and 4 low channels	
	Single mode: 8 high channels and a common channel	
Operation display	The lamp lights when power is supplied to the unit	
	The lamp lights when the specified channels are used	
Relay area	Maximum open and closed voltage	5000 V DC, 5000 V AC
	Maximum open and closed current	1.0 A (open and closed capacity: 50 W)
	Contact point indirect contact resistance	500 mΩ or less, with 1 mA AC
	Contact point maximum capacity	50 W
	Operation time	6 ms or less
	Recovery time	6 ms or less
Operation temperature range	0°C to 40°C, 80% RH or less (no condensation)	
Power	VSCV 24 V DC, ±10% (applied using the control signal input connector)	
Dimensions	Approx. 316W×100H×350D mm (12.4W×3.9H×13.8D in.) (excluding protruding parts)	
mass	4.2 kg (148.1 oz)	

## SAFETY TEST DATA MANAGEMENT SOFTWARE 9267

PC-controlled Testing of Insulation, Withstand Voltage (Hipot), Protective Continuity, and Leakage Current



1. Control the electrical safety measuring instruments from a computer
2. Perform automatic insulation and dielectric strength (hipot) testing of up to 32 points with the High Voltage Scanner 3930
3. Easily create and save insulation, dielectric strength, and continuity test records with a computer as required by the Electrical Appliance and Material Safety Act (Japan)

### Model No. (Order Code)

9267 For ST5540/ST5541, 3153 and similar products

This dedicated application allows you to control and take measurements through insulation testing, dielectric strength (hipot) testing, protective continuity testing, leak current testing, and energization testing and to record test results as a text file.

### Basic specifications

Compatible models	ST5520*, ST5540/ST5541, 3153, 3154, 3156, 3157, 3158, 3159, 3174, 3332, 3333, 3334, and PLCs from various manufacturers (for connection switching) *Control of the ST5520 is subject to certain limitations.
Supplied media	CD-R x1
Operating environment	Windows 10 (32/64bit), Windows 7 (32/64bit), Vista (32bit), XP/2000
Test types	Insulation and dielectric strength, protective continuity, leak current, energization
Recording data	Recording of test results (measured values) as a text file (CSV format)
Interfaces	RS-232C

## Options

Common options for 3174 and 3153



REMOTE CONTROL BOX (SINGLE)  
9613  
For Start/Stop control,  
1.5m (4.92 ft) cord length



REMOTE CONTROL BOX (DUAL)  
9614  
For Start/Stop control,  
1.5m (4.92 ft) cord length



RS-232C CABLE  
9637  
9 pin - 9 pin, cross,  
1.8 m (5.91 ft) length

3153 options



GP-IB CONNECTOR CABLE  
9151-02  
2 m (6.56 ft) length

3930 options



H.V. TEST LEAD  
9151-01  
Red, high voltage side,  
1.5 m (4.92 ft) length

Note: Company names and product names appearing in this brochure are trademarks or registered trademarks of various companies.

# HIOKI

HIOKI E. E. CORPORATION

DISTRIBUTED BY

### HEADQUARTERS

81 Koizumi,  
Ueda, Nagano 386-1192 Japan

<https://www.hioki.com/>



Scan for all  
regional contact  
information